



TERESE XTE

Differenziarsi è un fattore di successo: nel mondo dell'illuminazione la versatilità è un'aspetto importante. È così che da TERES nasce la versione EXTE, che permette l'applicazione dell'apparecchio su singolo punto luce sia con supporto esterno che incassato. La gamma TERES si distingue inoltre per l'eccellente resa cromatica, capace di esaltare la qualità e l'effetto brillante di ogni colore.

Design ESSE-CI.

- η** >96 lm/W
- CRI** >80; >90
- IP** 40

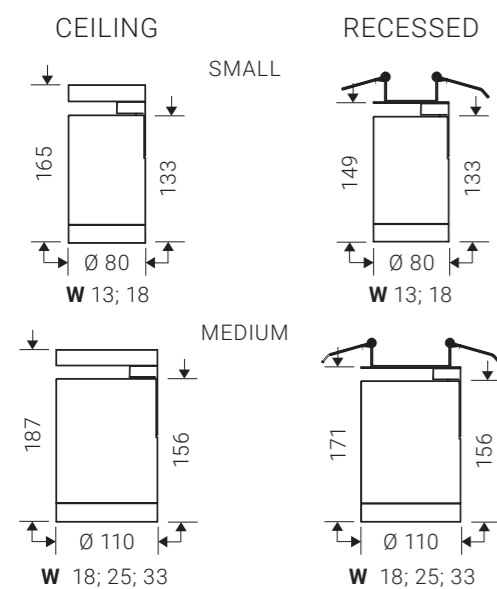



TERES EXTE



Design
ESSE-CI

DESCRIZIONE

Da TERES nasce TERES EXTE, lo spotlight innovativo installabile sia a plafone che ad incasso. Con il driver nascosto nel corpo lampada, riesce ad adattarsi a tutte le situazioni e colpisce per il suo design minimalista e la purezza delle forme. Sa creare una perfetta armonia tra illuminazione generale e raffinati accenti di luce.

SPECIFICHE

Driver integrato

Temperatura colore: 3000K/4000K

CRI>80; CRI>90

McAdams 3

Life Time: 50.000 h - Garanzia integrale 5 anni

Sicurezza degli occhi: privo di rischio (RG 0) in conformità con EN62471:2009

STABILITÀ DEL FLUSSO

CORRENTE	L90/B10	L90/B50	L80/B10	L80/B50	L70/B10	L70/B50*
350mA	55.000h	60.000h	60.000h	60.000h	60.000h	60.000h
500mA	55.000h	60.000h	60.000h	60.000h	60.000h	60.000h
700mA	55.000h	60.000h	60.000h	60.000h	60.000h	60.000h

* Es. L70 = flusso luminoso residuo garantito per l'apparecchio 70%

B50 = 50% dei diodi potranno avere flusso luminoso ridotto inferiore a 70%

OTTICHE

VT riflettori interni in alluminio con emissioni 10° - 20° - 40° - 50° - 70°

PC lenti in policarbonato con emissioni 12° - 24°

Vetro satinato

Ottica microrigata

Ottica a nido d'ape

CORPO

Realizzato in pressofusione di alluminio.

RIFERIMENTO NORMATIVO

Gli apparecchi sono conformi alle norme di sicurezza EN 60 598-1 e UNI EN 12464-2 (illuminazione ambienti di lavoro).

CERTIFICAZIONI

CE IP 40

Classe ErP: A⁺

CROMIE

Bianco RAL 9003 raggrinzante - Codice: W

Nero RAL 9005 raggrinzante - Codice: BK

A RICHIESTA

- Temperatura colore 2700K/5000K
- Cablaggio dimmerabile DALI - Codice: RDD (verificare le versioni disponibili)

TERES EXTE VT CEILING SMALL

OTTICA

Riflettori interni in alluminio.

Fascio: 10° - 20° - 40° - 50°.

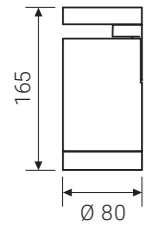

COD		lm
14VT13L410SP	13W 10° 4000K	1239
14VT13L420SP	13W 20° 4000K	1239
14VT13L440SP	13W 40° 4000K	1239
14VT13L450SP	13W 50° 4000K	1239

14VT18L410SP	18W 10° 4000K	1715
14VT18L420SP	18W 20° 4000K	1715
14VT18L440SP	18W 40° 4000K	1715
14VT18L450SP	18W 50° 4000K	1715

COD		lm
14VT13L310SP	13W 10° 3000K	1187
14VT13L320SP	13W 20° 3000K	1187
14VT13L340SP	13W 40° 3000K	1187
14VT13L350SP	13W 50° 3000K	1187

14VT18L310SP	18W 10° 3000K	1644
14VT18L320SP	18W 20° 3000K	1644
14VT18L340SP	18W 40° 3000K	1644
14VT18L350SP	18W 50° 3000K	1644



IP 40

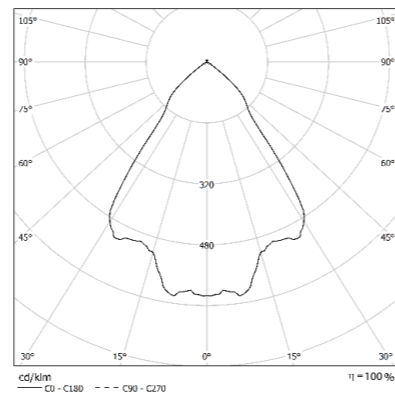

TERES EXTE VT CEILING SMALL Premium - CRI>90

OTTICA

Riflettori interni in alluminio.

Fascio: 10° - 20° - 40° - 50°.

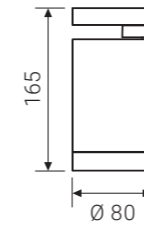

COD		lm
14VT13L410SP90	13W 10° 4000K	1072
14VT13L420SP90	13W 20° 4000K	1072
14VT13L440SP90	13W 40° 4000K	1072
14VT13L450SP90	13W 50° 4000K	1072

14VT18L410SP90	18W 10° 4000K	1485
14VT18L420SP90	18W 20° 4000K	1485
14VT18L440SP90	18W 40° 4000K	1485
14VT18L450SP90	18W 50° 4000K	1485

COD		lm
14VT13L310SP90	13W 10° 3000K	1020
14VT13L320SP90	13W 20° 3000K	1020
14VT13L340SP90	13W 40° 3000K	1020
14VT13L350SP90	13W 50° 3000K	1020

14VT18L310SP90	18W 10° 3000K	1413
14VT18L320SP90	18W 20° 3000K	1413
14VT18L340SP90	18W 40° 3000K	1413
14VT18L350SP90	18W 50° 3000K	1413



IP 40

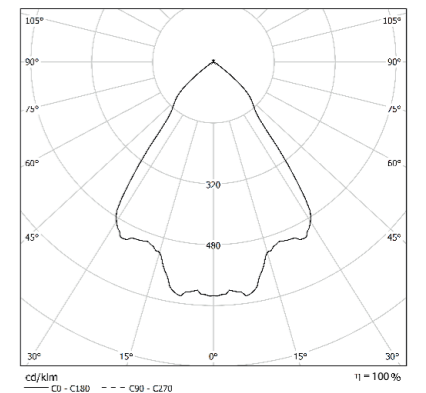

TERES EXTE VT CEILING MEDIUM

OTTICA

Riflettori interni in alluminio.
Fascio: 10° - 20° - 40° - 70°.

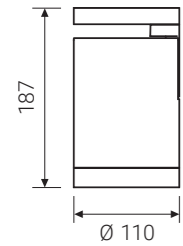

COD		lm
14VT18L410MP	18W 10° 4000K	2490
14VT18L420MP	18W 20° 4000K	2490
14VT18L440MP	18W 40° 4000K	2490
14VT18L470MP	18W 70° 4000K	2490
14VT25L410MP	25W 10° 4000K	3388
14VT25L420MP	25W 20° 4000K	3388
14VT25L440MP	25W 40° 4000K	3388
14VT25L470MP	25W 70° 4000K	3388
14VT33L410MP	33W 10° 4000K	4472
14VT33L420MP	33W 20° 4000K	4472
14VT33L440MP	33W 40° 4000K	4472
14VT33L470MP	33W 70° 4000K	4472

COD		lm
14VT18L310MP	18W 10° 3000K	2409
14VT18L320MP	18W 20° 3000K	2409
14VT18L340MP	18W 40° 3000K	2409
14VT18L370MP	18W 70° 3000K	2409
14VT25L310MP	25W 10° 3000K	3277
14VT25L320MP	25W 20° 3000K	3277
14VT25L340MP	25W 40° 3000K	3277
14VT25L370MP	25W 70° 3000K	3277
14VT33L310MP	33W 10° 3000K	4326
14VT33L320MP	33W 20° 3000K	4326
14VT33L340MP	33W 40° 3000K	4326
14VT33L370MP	33W 70° 3000K	4326



IP 40

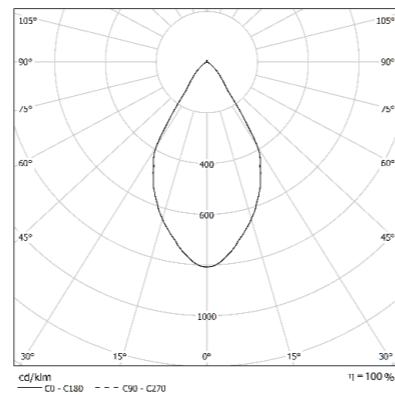

TERES EXTE VT CEILING MEDIUM Premium - CRI>90

OTTICA

Riflettori interni in alluminio.
Fascio: 10° - 20° - 40° - 70°.

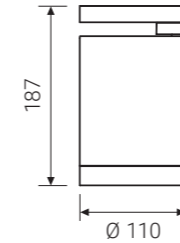

COD		lm
14VT18L410MP90	18W 10° 4000K	2051
14VT18L420MP90	18W 20° 4000K	2051
14VT18L440MP90	18W 40° 4000K	2051
14VT18L470MP90	18W 70° 4000K	2051
14VT25L410MP90	25W 10° 4000K	2790
14VT25L420MP90	25W 20° 4000K	2790
14VT25L440MP90	25W 40° 4000K	2790
14VT25L470MP90	25W 70° 4000K	2790
14VT33L410MP90	33W 10° 4000K	3683
14VT33L420MP90	33W 20° 4000K	3683
14VT33L440MP90	33W 40° 4000K	3683
14VT33L470MP90	33W 70° 4000K	3683

COD		lm
14VT18L310MP90	18W 10° 3000K	1985
14VT18L320MP90	18W 20° 3000K	1985
14VT18L340MP90	18W 40° 3000K	1985
14VT18L370MP90	18W 70° 3000K	1985
14VT25L310MP90	25W 10° 3000K	2701
14VT25L320MP90	25W 20° 3000K	2701
14VT25L340MP90	25W 40° 3000K	2701
14VT25L370MP90	25W 70° 3000K	2701
14VT33L310MP90	33W 10° 3000K	3566
14VT33L320MP90	33W 20° 3000K	3566
14VT33L340MP90	33W 40° 3000K	3566
14VT33L370MP90	33W 70° 3000K	3566



IP 40

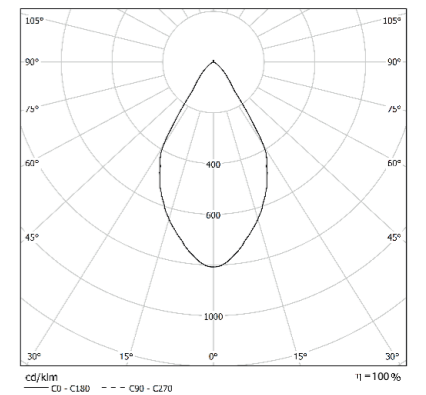

TERES EXTE VT RECESSED SMALL

OTTICA

Riflettori interni in alluminio.

Fascio: 10° - 20° - 40° - 50°.

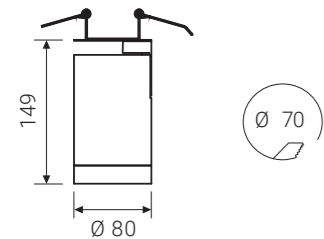

IP 40 A*

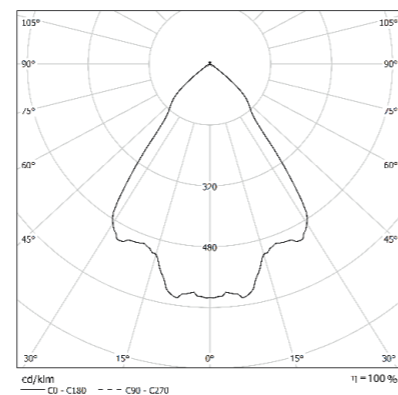

COD	Icona	lm
14VT13L410SR	13W 10° 4000K	1239
14VT13L420SR	13W 20° 4000K	1239
14VT13L440SR	13W 40° 4000K	1239
14VT13L450SR	13W 50° 4000K	1239
14VT18L410SR	18W 10° 4000K	1715
14VT18L420SR	18W 20° 4000K	1715
14VT18L440SR	18W 40° 4000K	1715
14VT18L450SR	18W 50° 4000K	1715

COD	Icona	lm
14VT13L310SR	13W 10° 3000K	1187
14VT13L320SR	13W 20° 3000K	1187
14VT13L340SR	13W 40° 3000K	1187
14VT13L350SR	13W 50° 3000K	1187
14VT18L310SR	18W 10° 3000K	1644
14VT18L320SR	18W 20° 3000K	1644
14VT18L340SR	18W 40° 3000K	1644
14VT18L350SR	18W 50° 3000K	1644

TERES EXTE VT RECESSED SMALL Premium - CRI>90

OTTICA

Riflettori interni in alluminio.

Fascio: 10° - 20° - 40° - 50°.

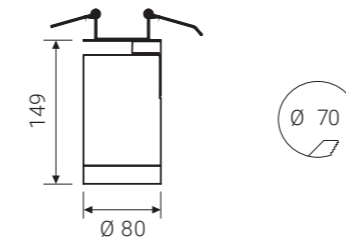

IP 40 A*

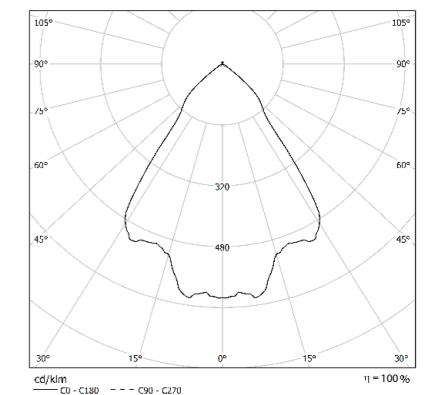

COD	Icona	lm
14VT13L410SR90	13W 10° 4000K	1072
14VT13L420SR90	13W 20° 4000K	1072
14VT13L440SR90	13W 40° 4000K	1072
14VT13L450SR90	13W 50° 4000K	1072
14VT18L410SR90	18W 10° 4000K	1485
14VT18L420SR90	18W 20° 4000K	1485
14VT18L440SR90	18W 40° 4000K	1485
14VT18L450SR90	18W 50° 4000K	1485

COD	Icona	lm
14VT13L310SR90	13W 10° 3000K	1020
14VT13L320SR90	13W 20° 3000K	1020
14VT13L340SR90	13W 40° 3000K	1020
14VT13L350SR90	13W 50° 3000K	1020
14VT18L310SR90	18W 10° 3000K	1413
14VT18L320SR90	18W 20° 3000K	1413
14VT18L340SR90	18W 40° 3000K	1413
14VT18L350SR90	18W 50° 3000K	1413

TERES EXTE VT RECESSED MEDIUM

OTTICA

Riflettori interni in alluminio.
Fascio: 10° - 20° - 40° - 70°.

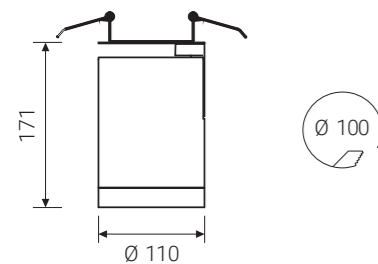

IP 40 A+

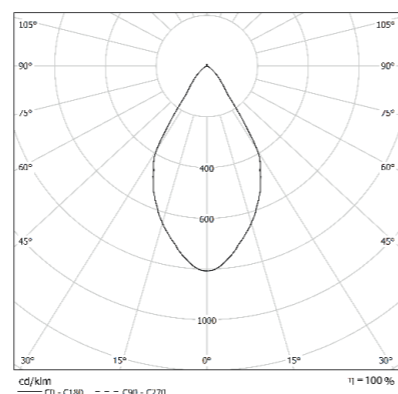

COD	Light Bulb Icon	lm
14VT18L410MR	18W 10° 4000K	2490
14VT18L420MR	18W 20° 4000K	2490
14VT18L440MR	18W 40° 4000K	2490
14VT18L470MR	18W 70° 4000K	2490
14VT25L410MR	25W 10° 4000K	3388
14VT25L420MR	25W 20° 4000K	3388
14VT25L440MR	25W 40° 4000K	3388
14VT25L470MR	25W 70° 4000K	3388
14VT33L410MR	33W 10° 4000K	4472
14VT33L420MR	33W 20° 4000K	4472
14VT33L440MR	33W 40° 4000K	4472
14VT33L470MR	33W 70° 4000K	4472
COD	Light Bulb Icon	lm
14VT18L310MR	18W 10° 3000K	2409
14VT18L320MR	18W 20° 3000K	2409
14VT18L340MR	18W 40° 3000K	2409
14VT18L370MR	18W 70° 3000K	2409
14VT25L310MR	25W 10° 3000K	3277
14VT25L320MR	25W 20° 3000K	3277
14VT25L340MR	25W 40° 3000K	3277
14VT25L370MR	25W 70° 3000K	3277
14VT33L310MR	33W 10° 3000K	4326
14VT33L320MR	33W 20° 3000K	4326
14VT33L340MR	33W 40° 3000K	4326
14VT33L370MR	33W 70° 3000K	4326

TERES EXTE VT RECESSED MEDIUM Premium - CRI>90

OTTICA

Riflettori interni in alluminio.
Fascio: 10° - 20° - 40° - 70°.

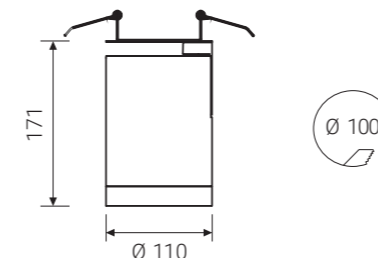

IP 40 A+

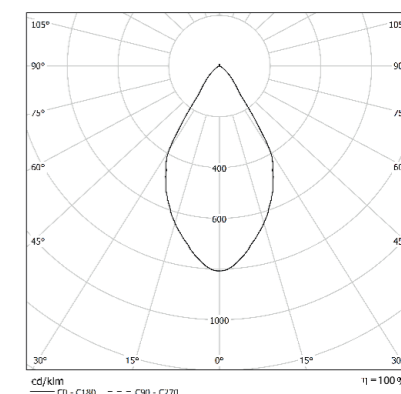

COD	Light Bulb Icon	lm
14VT18L410MR90	18W 10° 4000K	2051
14VT18L420MR90	18W 20° 4000K	2051
14VT18L440MR90	18W 40° 4000K	2051
14VT18L470MR90	18W 70° 4000K	2051
14VT25L410MR90	25W 10° 4000K	2790
14VT25L420MR90	25W 20° 4000K	2790
14VT25L440MR90	25W 40° 4000K	2790
14VT25L470MR90	25W 70° 4000K	2790
14VT33L410MR90	33W 10° 4000K	3683
14VT33L420MR90	33W 20° 4000K	3683
14VT33L440MR90	33W 40° 4000K	3683
14VT33L470MR90	33W 70° 4000K	3683
COD	Light Bulb Icon	lm
14VT18L310MR90	18W 10° 3000K	1985
14VT18L320MR90	18W 20° 3000K	1985
14VT18L340MR90	18W 40° 3000K	1985
14VT18L370MR90	18W 70° 3000K	1985
14VT25L310MR90	25W 10° 3000K	2701
14VT25L320MR90	25W 20° 3000K	2701
14VT25L340MR90	25W 40° 3000K	2701
14VT25L370MR90	25W 70° 3000K	2701
14VT33L310MR90	33W 10° 3000K	3566
14VT33L320MR90	33W 20° 3000K	3566
14VT33L340MR90	33W 40° 3000K	3566
14VT33L370MR90	33W 70° 3000K	3566

TERES EXTE PC CEILING SMALL

OTTICA

Lente in policarbonato.

Fascio: 12° - 24°.

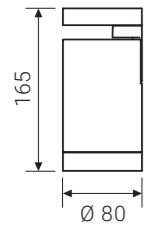

COD		lm
14PC13L412SP	13W 12° 4000K	1239
14PC13L424SP	13W 24° 4000K	1239

14PC18L412SP	18W 12° 4000K	1715
14PC18L424SP	18W 24° 4000K	1715

COD		lm
14PC13L312SP	13W 12° 3000K	1187
14PC13L324SP	13W 24° 3000K	1187

14PC18L312SP	18W 12° 3000K	1644
14PC18L324SP	18W 24° 3000K	1644



IP 40 

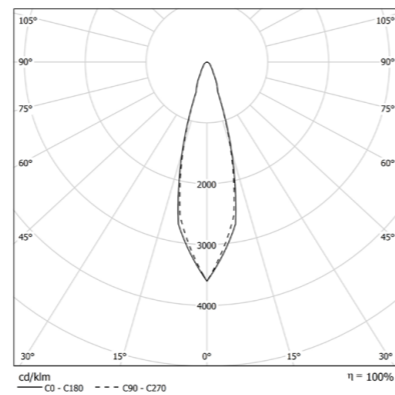



TERES EXTE PC CEILING SMALL Premium - CRI>90

OTTICA

Lente in policarbonato.

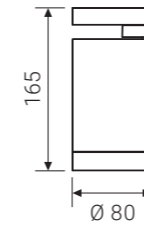
Fascio: 12° - 24°.



COD		lm
14PC13L412SP90	13W 12° 4000K	1072
14PC13L424SP90	13W 24° 4000K	1072

14PC18L412SP90	18W 12° 4000K	1485
14PC18L424SP90	18W 24° 4000K	1485

COD		lm
14PC13L312SP90	13W 12° 3000K	1020
14PC13L324SP90	13W 24° 3000K	1020

14PC18L312SP90	18W 12° 3000K	1413
14PC18L324SP90	18W 24° 3000K	1413



IP 40 

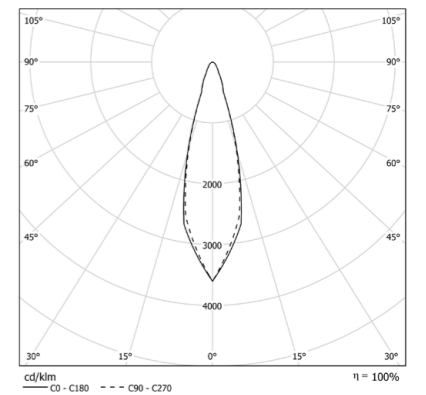



TERES EXTE PC CEILING MEDIUM

OTTICA

Lente in policarbonato.

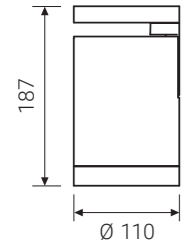
Fascio: 12° - 24°.



COD		lm
14PC18L412MP	18W 12° 4000K	2490
14PC18L424MP	18W 24° 4000K	2490
14PC25L412MP	25W 12° 4000K	3388
14PC25L424MP	25W 24° 4000K	3388
14PC33L412MP	33W 12° 4000K	4472
14PC33L424MP	33W 24° 4000K	4472

COD		lm
14PC18L312MP	18W 12° 3000K	2409
14PC18L324MP	18W 24° 3000K	2409
14PC25L312MP	25W 12° 3000K	3277
14PC25L324MP	25W 24° 3000K	3277
14PC33L312MP	33W 12° 3000K	4326
14PC33L324MP	33W 24° 3000K	4326



IP 40 

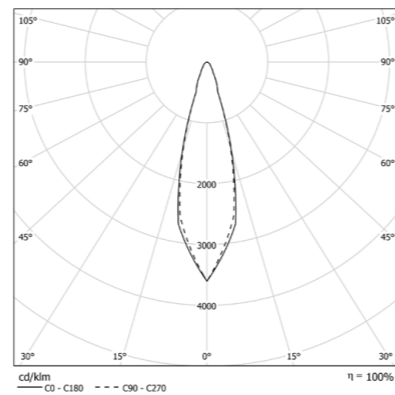



TERES EXTE PC CEILING MEDIUM Premium - CRI>90

OTTICA

Lente in policarbonato.

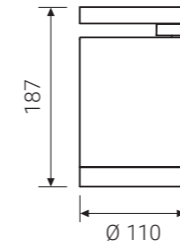
Fascio: 12° - 24°.



COD		lm
14PC18L412MP90	18W 12° 4000K	2051
14PC18L424MP90	18W 24° 4000K	2051
14PC25L412MP90	25W 12° 4000K	2790
14PC25L424MP90	25W 24° 4000K	2790
14PC33L412MP90	33W 12° 4000K	3683
14PC33L424MP90	33W 24° 4000K	3683

COD		lm
14PC18L312MP90	18W 12° 3000K	1985
14PC18L324MP90	18W 24° 3000K	1985
14PC25L312MP90	25W 12° 3000K	2701
14PC25L324MP90	25W 24° 3000K	2701
14PC33L312MP90	33W 12° 3000K	3566
14PC33L324MP90	33W 24° 3000K	3566



IP 40 

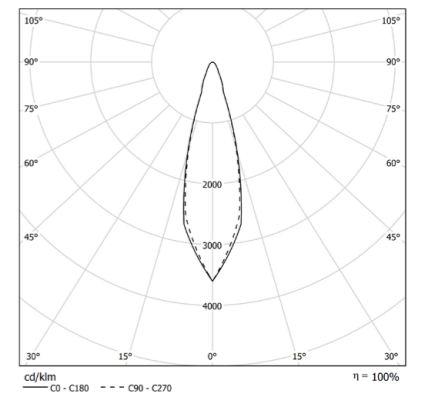

TERES EXTE PC RECESSED SMALL

OTTICA

Lente in policarbonato.

Fascio: 12° - 24°.

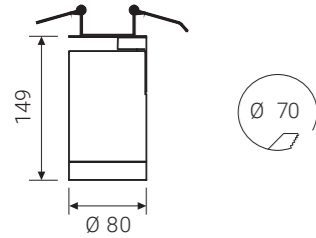

COD		lm
14PC13L412SR	13W 12° 4000K	1239
14PC13L424SR	13W 24° 4000K	1239

14PC18L412SR	18W 12° 4000K	1715
14PC18L424SR	18W 24° 4000K	1715

COD		lm
14PC13L312SR	13W 12° 3000K	1187
14PC13L324SR	13W 24° 3000K	1187

14PC18L312SR	18W 12° 3000K	1644
14PC18L324SR	18W 24° 3000K	1644



IP 40

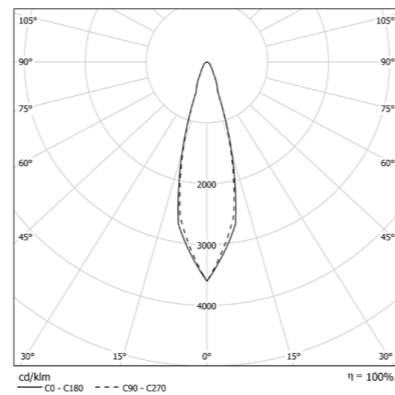

TERES EXTE PC RECESSED SMALL Premium - CRI>90

OTTICA

Lente in policarbonato.

Fascio: 12° - 24°.

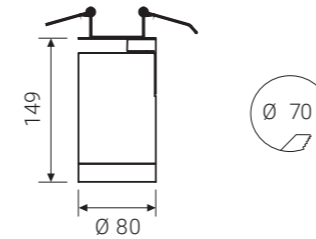

COD		lm
14PC13L412SR90	13W 12° 4000K	1072
14PC13L424SR90	13W 24° 4000K	1072

14PC18L412SR90	18W 12° 4000K	1485
14PC18L424SR90	18W 24° 4000K	1485

COD		lm
14PC13L312SR90	13W 12° 3000K	1020
14PC13L324SR90	13W 24° 3000K	1020

14PC18L312SR90	18W 12° 3000K	1413
14PC18L324SR90	18W 24° 3000K	1413



IP 40

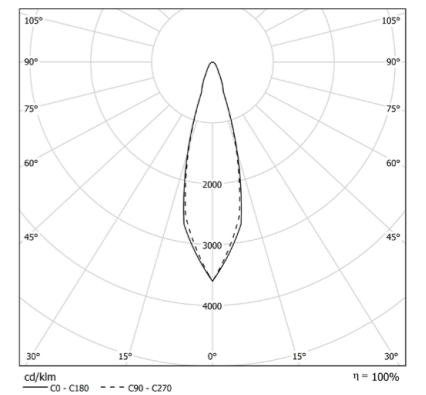

TERES EXTE PC RECESSED MEDIUM

OTTICA

Lente in policarbonato.

Fascio: 12° - 24°.

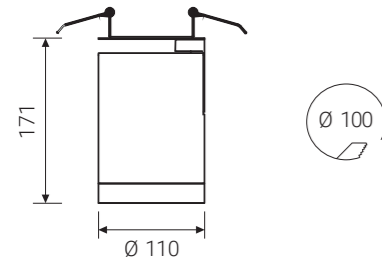

IP 40 A+

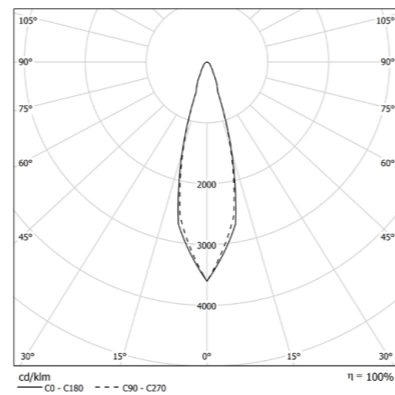

COD	Light Bulb Icon	lm
14PC18L412MR	18W 12° 4000K	2490
14PC18L424MR	18W 24° 4000K	2490
14PC25L412MR	25W 12° 4000K	3388
14PC25L424MR	25W 24° 4000K	3388
14PC33L412MR	33W 12° 4000K	4472
14PC33L424MR	33W 24° 4000K	4472
COD	Light Bulb Icon	lm
14PC18L312MR	18W 12° 3000K	2409
14PC18L324MR	18W 24° 3000K	2409
14PC25L312MR	25W 12° 3000K	3277
14PC25L324MR	25W 24° 3000K	3277
14PC33L312MR	33W 12° 3000K	4326
14PC33L324MR	33W 24° 3000K	4326

TERES EXTE PC RECESSED MEDIUM Premium - CRI>90

OTTICA

Lente in policarbonato.

Fascio: 12° - 24°.

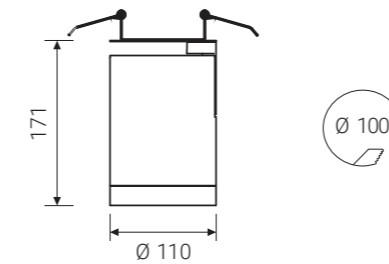

IP 40 A+

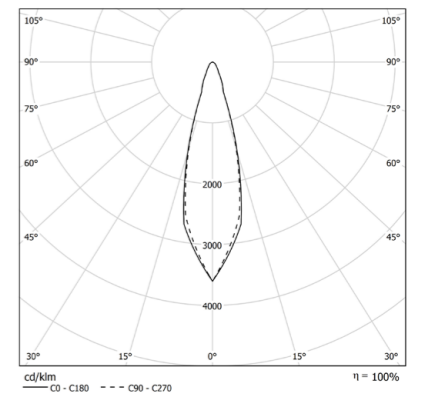

COD	Light Bulb Icon	lm
14PC18L412MR90	18W 12° 4000K	2051
14PC18L424MR90	18W 24° 4000K	2051
14PC25L412MR90	25W 12° 4000K	2790
14PC25L424MR90	25W 24° 4000K	2790
14PC33L412MR90	33W 12° 4000K	3683
14PC33L424MR90	33W 24° 4000K	3683
COD	Light Bulb Icon	lm
14PC18L312MR90	18W 12° 3000K	1985
14PC18L324MR90	18W 24° 3000K	1985
14PC25L312MR90	25W 12° 3000K	2701
14PC25L324MR90	25W 24° 3000K	2701
14PC33L312MR90	33W 12° 3000K	3566
14PC33L324MR90	33W 24° 3000K	3566

ACCESSORI

OTTICHE TERES VT



14AAMGS
TERES VT SMALL vetro satinato.



14AAMGM
TERES VT MEDIUM vetro satinato.

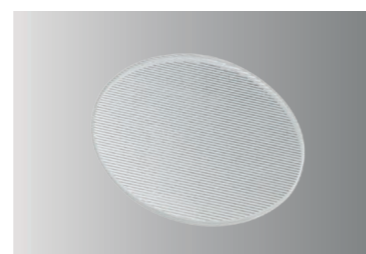

14AASLM
TERES VT MEDIUM ottica microrigata.

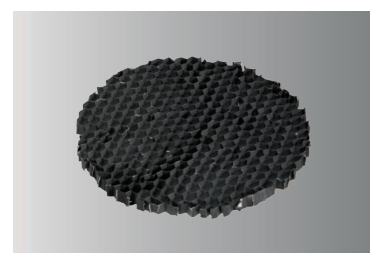

14AANDM
TERES VT MEDIUM ottica a nido d'ape.

NOTE TECNICHE

FLESSIBILITÀ DEL CORPO

TERES EXTE ruota su due assi e permette di illuminare correttamente gli oggetti direzionando il facio luminoso a piacere.

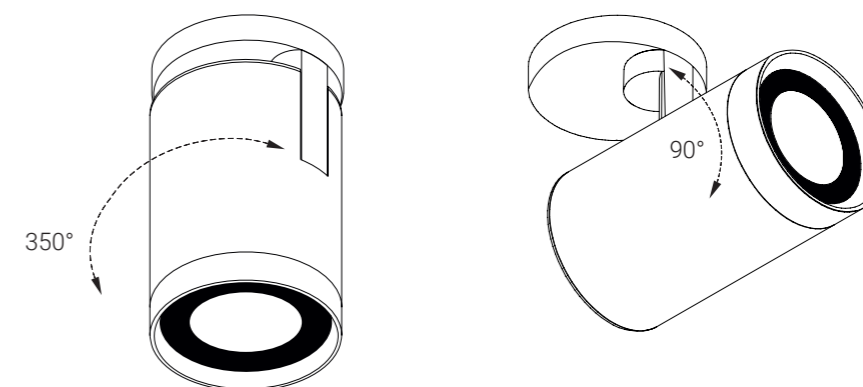

TERES EXTE CEILING

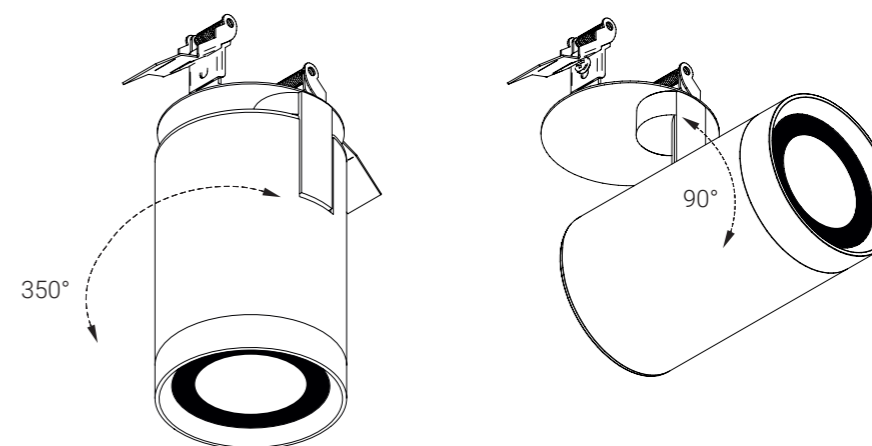

TERES EXTE RECESSED